

# Cable-Extension Position Transducer

0...5, 0...10, -5...+5, -10...+10 VDC Output Options  
 Ranges: 0-75 to 0-550 inches  
 Industrial Grade

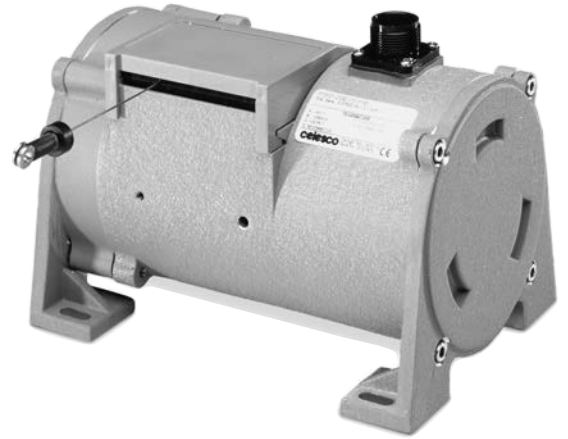

# PT9510



## Specification Summary:

### GENERAL

Full Stroke Range Options—on this datasheet ..... 0-75 to 0-550 inches  
 Output Signal Options ..... 0...10, 0...5, -5...+5, -10...+10 VDC  
 Accuracy .....  $\pm 0.12\%$  full stroke  
 Repeatability .....  $\pm 0.05\%$  full stroke  
 Resolution ..... essentially infinite  
 Measuring Cable Options ..... nylon-coated stainless steel or thermoplastic  
 Enclosure Material ..... powder-painted aluminum or stainless steel  
 Sensor ..... plastic-hybrid precision potentiometer  
 Potentiometer Cycle Life ..... 250,000, min.—before signal degradation can occur  
 Maximum Retraction Acceleration ..... see ordering information  
 Maximum Velocity ..... see ordering information  
 Weight, Aluminum (Stainless Steel) Enclosure ..... 8 lbs. (16 lbs.) max.

### ELECTRICAL

Input Voltage ..... 14.5-40VDC (10.5-40VDC for 0-5 volt output)  
 Input Current ..... 10 mA maximum  
 Output Impedance ..... 1000 ohms  
 Maximum Output Load ..... 5000 ohms  
 Zero and Span Adjustment ..... see ordering information

### ENVIRONMENTAL

Enclosure ..... NEMA 4/4X/6, IP 67/68  
 Operating Temperature ..... -40° to 200°F (-40° to 90°C)  
 Vibration ..... up to 10 G's to 2000 Hz maximum

### EMC COMPLIANCE PER DIRECTIVE 89/336/EEC

Emission / Immunity ..... EN50081-2 / EN50082-2

The PT9510 can operate from an unregulated 14.5 to 40 VDC power supply while providing a regulated output signal over it's full extended range of up to 1700". It provides a 0 - 10VDC position feedback signal proportional to the linear movement of it's stainless steel measuring cable.

As a member of Celesco's innovative family of NEMA-4 rated cable-extension transducers, the PT9510 offers numerous benefits. It installs in minutes, functions properly without perfectly parallel alignment, and when its cable is retracted, it measures only 6".

Fig. 1 – Outline Drawing (18 oz. cable tension only)

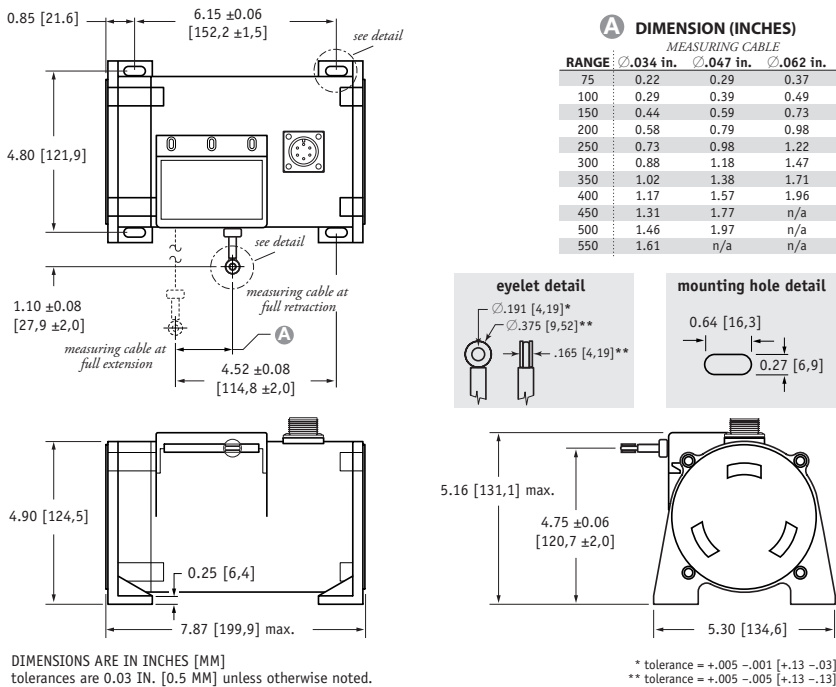

## Output Signal

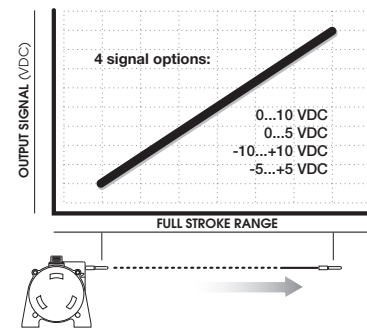

**Ordering Information:**

**Model Number:**

**PT9510-** \_\_\_\_\_ **- 1** \_\_\_\_\_ **0**  
order code:                      R                      A                      B                      C                      D                      E                      F                      G

Sample Model Number:

**PT9510 - 0500 - 111 - 1110**

- R** range: 500 inches
- A** enclosure/cable tension: aluminum/18 oz.
- B** measuring cable: .034 nylon-coated stainless front
- C** cable exit: front
- E** output signal: 0...10 vdc
- F** electrical connection: 6-pin plastic connector

**Full Stroke Range:**

<b>R</b> order code:	<b>0075</b>	<b>0100</b>	<b>0150</b>	<b>0200</b>	<b>0250</b>	<b>0300</b>	<b>0350</b>	<b>0400</b>	<b>0450*</b>	<b>0500*</b>	<b>0550*</b>
full stroke range, min:	75 in.	100 in.	150 in.	200 in.	250 in.	300 in.	350 in.	400 in.	450 in.	500 in.	550 in.

\* - 36 oz. cable tension strongly recommended

**Enclosure Material and Measuring Cable Tension:**

<b>A</b> order code:	<b>1</b>	<b>3</b>	<b>2</b>	<b>4</b>
tension (±30%):	18 oz.		36 oz.	
enclosure material:	powder-painted aluminum	303 stainless steel	powder-painted aluminum	303 stainless steel
max. acceleration:	1 G	.33 G	5 G	2 G
max. velocity:	60 inches/sec	20 inches/sec	200 inches/sec	80 inches/sec

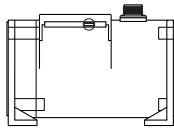

standard housing  
see fig 1.

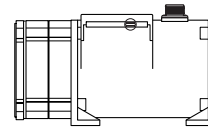

dual-spring housing  
see fig 2.

**Measuring Cable:**

<b>B</b> order code:	<b>1</b>	<b>2</b>	<b>3</b>
	∅.034-inch nylon-coated stainless steel <i>available in all ranges</i>	∅.047-inch stainless steel <i>all ranges up to 500 inches</i>	∅.062-inch thermoplastic <i>all ranges up to 400 inches</i>

**Cable Exit:**

<b>C</b> order code:	<b>1</b>	<b>2</b>	<b>3</b>	<b>4</b>
	front	top	back	down

**Output Signals:**

<b>B</b> order code:	<b>1</b>	<b>2</b>	<b>3</b>	<b>4</b>	<b>5</b>	<b>6</b>	<b>7</b>	<b>8</b>
output signal options:	0...10 VDC	10...0 VDC	0...5 VDC	5...0 VDC	-10...+10 VDC	+10...-10 VDC	-5...+5 VDC	+5...-5 VDC
input voltage:	14.5 - 40 vdc		10.5 - 40 vdc		14.5 - 40 vdc		10.5 - 40 vdc	
span adjustment:	to 50% of full stroke range				to 75% of full stroke range			
zero adjustment:	from factory set zero to 50% of full stroke range				from factory set zero to 25% of full stroke range			



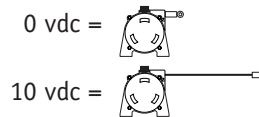

example:

ordercode = **1** = 0...10 VDC



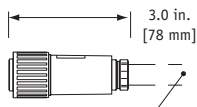
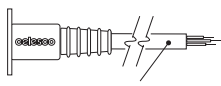
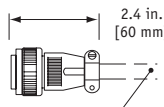

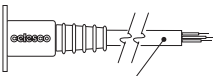
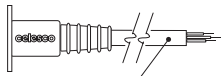
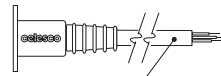

**Ordering Information:**

**Electrical Connection:**

<p><b>1</b></p> <p>6-pin plastic connector w/mating plug <b>IP 67, NEMA 4X**, 6</b></p>  <p>1/2 - 5/16" [14 - 8 mm] cable dia. 16 AWG max conductor size connector: MS3102E-14S-6P mating plug: MS3106E-14S-6S</p>	<p><b>2</b></p> <p>10-ft. [3 M] waterproof cable <b>IP 67, NEMA 4X**, 6</b></p>  <p>10 ft. x 0.4-in. dia. [3 M x 10 mm dia.] 18 AWG, type SJTW</p>	<p><b>3</b></p> <p>6-pin metal connector w/mating plug <b>IP 65, NEMA 4</b></p>  <p>3/8-in. [9 mm] max cable dia. 16 AWG max conductor size connector: MS3102E-14S-6P mating plug: MS3106E-14S-6S</p>	<p><b>4</b></p> <p>25-ft. [7.5 M] instrumentation cable <b>IP 67, NEMA 6</b></p>  <p>25 ft. x 0.2-in. dia. [7.5 M x 5 mm dia.] 24 AWG, shielded</p>																								
<p><b>5</b></p> <p>100-ft. [30 M] waterproof cable <b>IP 67, NEMA 4X**, 6</b></p>  <p>100 ft. x 0.4-in. dia. [30 M x 10 mm dia.] 18 AWG, type SJTW</p>	<p><b>6</b></p> <p>10-ft. [3 M] pressure tested* waterproof cable <b>IP 68, NEMA 4X**, 6P</b></p>  <p>10 ft. x 0.4-in. dia. [3 M x 10 mm dia.] 18 AWG, type SJTW</p>	<p><b>7</b></p> <p>100-ft. [30 M] pressure tested* waterproof cable <b>IP 68, NEMA 4X**, 6P</b></p>  <p>100 ft. x 0.4-in. dia. [30 M x 10 mm dia.] 18 AWG, type SJTW</p>																									
<p><b>6-pin Mating Plug</b></p> <table border="0"> <tr> <td>pin</td> <td>signal</td> </tr> <tr> <td>A</td> <td>input voltage</td> </tr> <tr> <td>B</td> <td>output signal</td> </tr> <tr> <td>C</td> <td>common</td> </tr> </table>  <p>contact view</p>		pin	signal	A	input voltage	B	output signal	C	common	<p><b>Waterproof Cable</b></p> <table border="0"> <tr> <td>color code</td> <td>signal</td> </tr> <tr> <td>WHITE</td> <td>input voltage</td> </tr> <tr> <td>GREEN</td> <td>output signal</td> </tr> <tr> <td>BLACK</td> <td>common</td> </tr> </table> <p><b>Instrumentation Cable</b></p> <table border="0"> <tr> <td>color code</td> <td>signal</td> </tr> <tr> <td>RED</td> <td>input voltage</td> </tr> <tr> <td>GREEN</td> <td>output signal</td> </tr> <tr> <td>BLACK</td> <td>common</td> </tr> </table>		color code	signal	WHITE	input voltage	GREEN	output signal	BLACK	common	color code	signal	RED	input voltage	GREEN	output signal	BLACK	common
pin	signal																										
A	input voltage																										
B	output signal																										
C	common																										
color code	signal																										
WHITE	input voltage																										
GREEN	output signal																										
BLACK	common																										
color code	signal																										
RED	input voltage																										
GREEN	output signal																										
BLACK	common																										

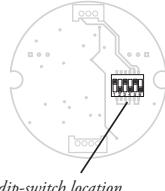
Notes: { \* -Test pressure: 100 feet [30 meters] H<sub>2</sub>O (40 PSID); Test Medium: Air; Duration: 2 hours.  
\*\* -NEMA 4X applies to stainless steel enclosure only.

Output Signal Selection (does not apply to -5...+5 & -10...+10 vdc options)

output signal	switch setting	signal board
0...10 vdc		
10...0 vdc		
0...5 vdc		
5...0 vdc		

To gain access to the signal board, remove four Allen-Head Screws and remove end cover bracket.

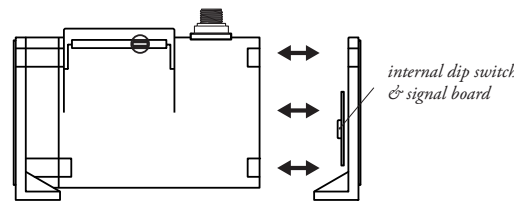

**Caution! Do Not Remove Spring-Side End Cover**  
Removing spring-side end cover could cause spring to become unseated and permanently damaged.

The output signal direction can be reversed at any time by simply changing the dip-switch settings found on the internal signal board. After the settings have been changed, adjustment of the Zero and Span trimpots will be required to precisely match signal values to the beginning and end points of the stroke.

Fig. 2 – Outline Drawing (36 oz. cable tension only)

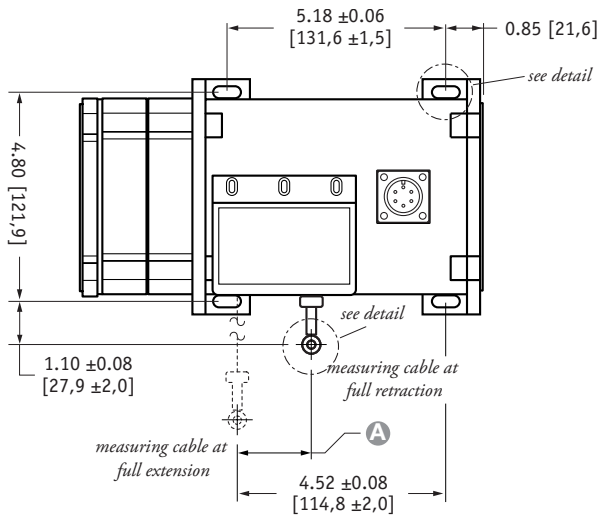

**A DIMENSION (INCHES)**

MEASURING CABLE			
RANGE	∅.034 in.	∅.047 in.	∅.062 in.
75	0.22	0.29	0.37
100	0.29	0.39	0.49
150	0.44	0.59	0.73
200	0.58	0.79	0.98
250	0.73	0.98	1.22
300	0.88	1.18	1.47
350	1.02	1.38	1.71
400	1.17	1.57	1.96
450	1.31	1.77	n/a
500	1.46	1.97	n/a
550	1.61	n/a	n/a

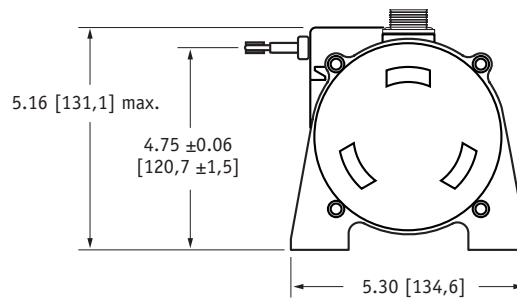
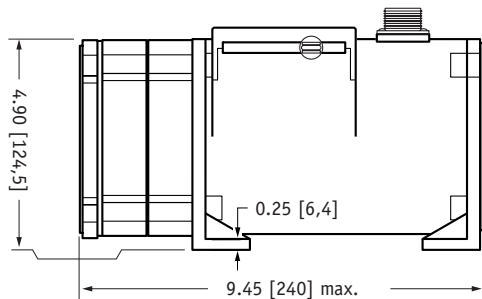
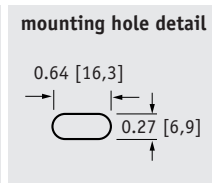
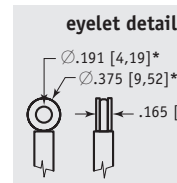

DIMENSIONS ARE IN INCHES [MM]  
tolerances are 0.03 IN. [0.5 MM] unless otherwise noted.

\* tolerance = +.005 -.001 [+.13 -.03]  
\*\* tolerance = +.005 -.005 [+ .13 -.13]