

String Encoder

Mates to Virtually Any Encoder
 Ranges: 0-75 to 0-550 inches
 Available With or Without Encoder

PT9600

Specification Summary:

GENERAL

Full Stroke Range Options—on this datasheet 0-75 to 0-550 inches
 Motion Conversion Ratio 12.6 inches per turn, see ordering information
 Accuracy
 Typical the lesser of 0.02% f.s. or 0.04% of measurement $\pm 1/2$ pulse max.
 Best not less than 0.001 in. (0.03 mm)
 Repeatability $\pm 0.02\%$ of measurement $\pm 1/2$ pulse max.
 Measuring Cable Options nylon-coated stainless steel or thermoplastic
 Enclosure Material Options powder-painted aluminum or stainless steel
 Encoder Shaft Coupling aluminum flexible coupling
 Maximum Allowable Rotational Sensor Torque 1.0 in.-lbs.
 Maximum Retraction Acceleration see ordering information
 Maximum Velocity see ordering information
 Weight, Aluminum (Stainless Steel) Enclosure 8 lbs. (16 lbs.) max.

ENVIRONMENTAL

Operating Temperature -40° to 200°F (-40° to 90°C)

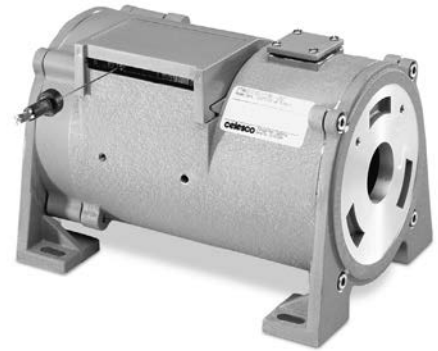

Our unique string encoder module mates to virtually any encoder, giving you a cost-effective long-range linear position measurement solution that precisely fits your requirements.

This modular approach delivers the ultimate in flexibility. To order, simply select the measurement range, the cable tension and encoder mounting style—it's that easy! We even supply all the necessary encoder mounting tools and attaching hardware. If you can't find your encoder mounting style or you want us to provide the encoder, please give us a call.

Fig. 1 – Outline Drawing (18 oz. cable tension only)

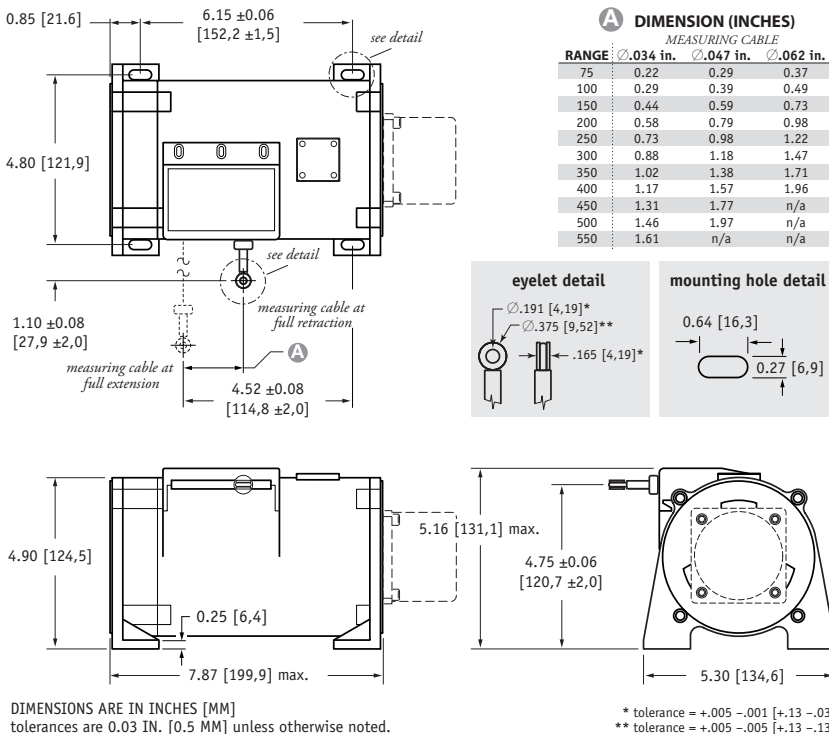

Ordering Information:

Model Number:

PT9600- _____ **R** _____ **A** _____ **B** _____ **G** _____ **D**
order code:

Sample Model Number:

PT9600 - 0200 - 111 - F01

- R** range: 200 inches
- A** enclosure / cable tension: aluminum / 18 oz.
- B** measuring cable: .034 nylon-coated stainless front
- G** cable exit: front
- D** rotational sensor mounting style: F01 (2.5-in. sq. flange)

» Trying to reorder but can't find your existing model number? Please contact factory for help.

Full Stroke Range:

R order code:	0075	0100	0150	0200	0250	0300	0350	0400	0450*	0500*	0550*
full stroke range, min:	75 in.	100 in.	150 in.	200 in.	250 in.	300 in.	350 in.	400 in.	450 in.	500 in.	550 in.

* - 36 oz. cable tension strongly recommended

Enclosure Material and Measuring Cable Tension:

A order code:	1	3	2	4
tension (±30%):	18 oz.		36 oz.	
enclosure material:	powder-painted aluminum	303 stainless steel	powder-painted aluminum	303 stainless steel
max. acceleration:	1 G	.33 G	5 G	2 G
max. velocity:	60 inches/sec	20 inches/sec	200 inches/sec	80 inches/sec

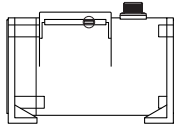

standard housing
see fig 1.

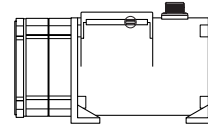

dual-spring housing
see fig 2.

Measuring Cable / Conversion Ratio:

B order code:	1	2	3
measuring cable:	.034 nylon-coated stainless steel	.047 stainless steel	.062 thermoplastic
conversion ratio, aluminum enclosure:	1 turn = 12.673 ± 0.010 in.	1 turn = 12.714 ± 0.010 in.	1 turn = 12.755 ± 0.010 in.
conversion ratio, stainless enclosure:	1 turn = 12.579 ± 0.010 in.	1 turn = 12.620 ± 0.010 in.	1 turn = 12.661 ± 0.010 in.
	available in <i>all ranges</i>	<i>all ranges up to 500 inches</i>	<i>all ranges up to 400 inches</i>

Cable Exit:

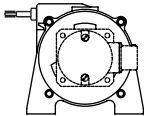
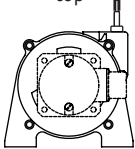
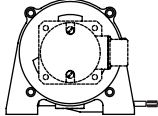
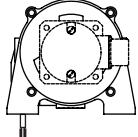
G order code:	1	2	3	4
	front	top	back	down
				

Ordering Information:

Rotational Sensor Mounting Style:

① order code:	F01	F02	S01	S02	S04
	2.5-in. Flange Mount 3/8-inch shaft	2-in. Flange Mount 3/8-inch shaft	Face-Mount 6 mm shaft M4 mounting screws	Face-Mount 10 mm shaft M4 mounting screws	Face-Mount 10 mm shaft M3 mounting screws

Note: If you don't see your encoder style, please contact factory. All encoder types supported.

F01 - 2½-inch Sq. Flange Mount (3/8-inch shaft)

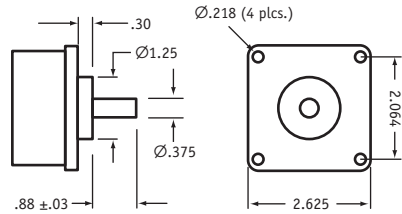

all dimensions are in inches

F02 - 2-inch Sq. Flange Mount (3/8-inch shaft)

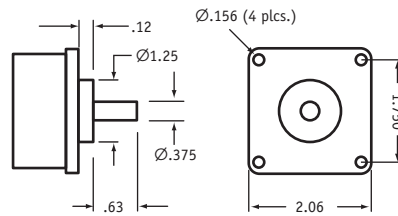

all dimensions are in inches

S01 - Face-Mount (6mm shaft/M4 screws)

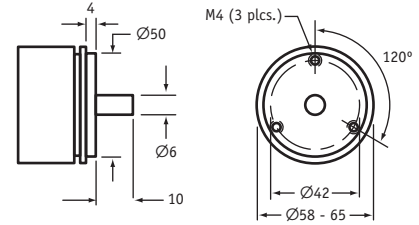

all dimensions are in mm

S02 - Face-Mount (10mm shaft/M4 screws)

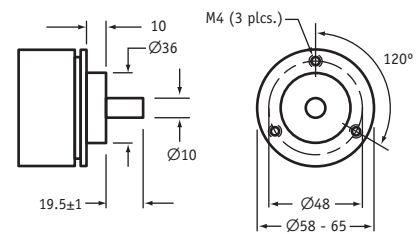

all dimensions are in mm

S04 - Face-Mount (10mm shaft/M3 screws)

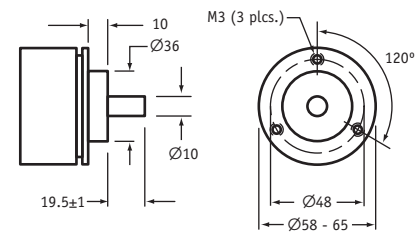

all dimensions are in mm

Fig. 2 – Outline Drawing (36 oz. cable tension only)

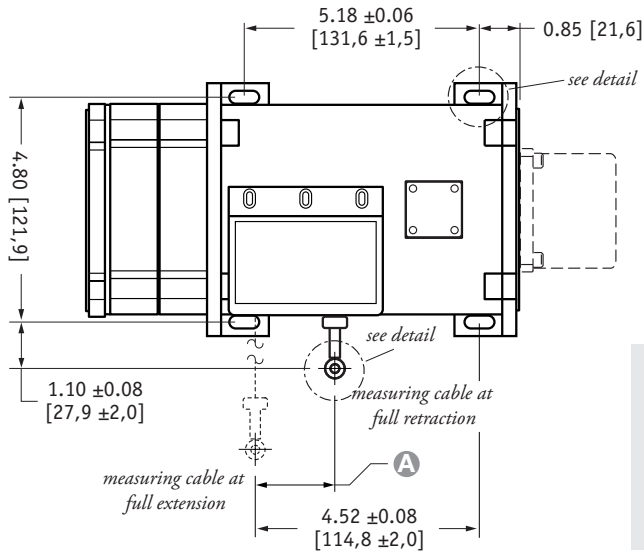

A DIMENSION (INCHES)

MEASURING CABLE

RANGE	Ø.034 in.	Ø.047 in.	Ø.062 in.
75	0.22	0.29	0.37
100	0.29	0.39	0.49
150	0.44	0.59	0.73
200	0.58	0.79	0.98
250	0.73	0.98	1.22
300	0.88	1.18	1.47
350	1.02	1.38	1.71
400	1.17	1.57	1.96
450	1.31	1.77	n/a
500	1.46	1.97	n/a
550	1.61	n/a	n/a

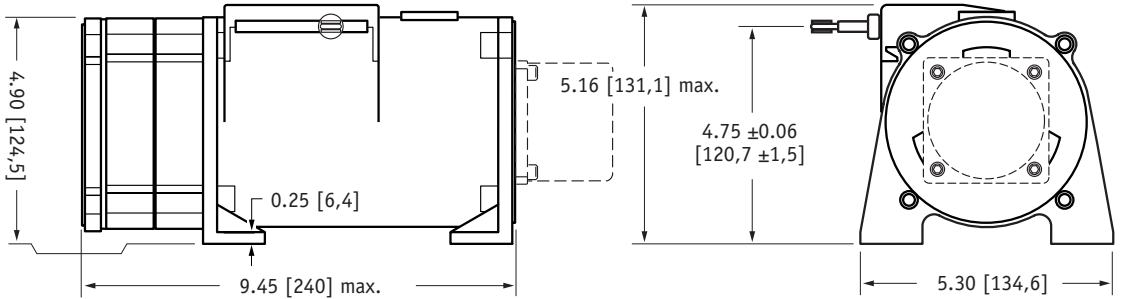
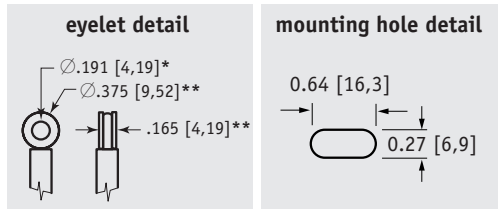

DIMENSIONS ARE IN INCHES [MM]
tolerances are 0.03 IN. [0.5 MM] unless otherwise noted.

* tolerance = +.005 -.001 [+13 -.03]
** tolerance = +.005 -.005 [+13 -.13]